

# INSTRUCTIONS FOR THE USE AND CARE OF ZANUSSI WASHER DRYER

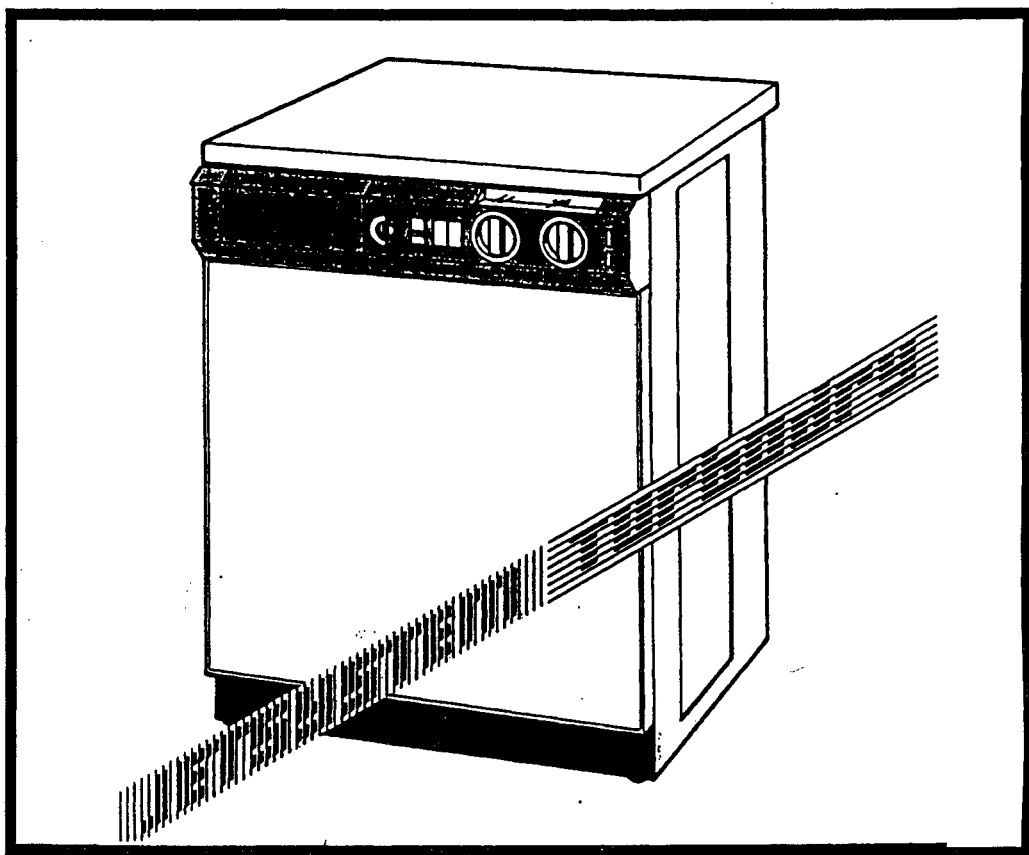

Model no  
WDJ1015/A

**ZANUSSI**  
The appliance of science

---

**It is most important that this instruction book should be retained with the appliance for future reference. Should the appliance be sold or transferred to another owner, or should you move house and leave the appliance, always ensure that the book is supplied with the appliance in order that the new owner can be acquainted with the functioning of the appliance and the relevant warnings.**

## **Warnings - Washer/Dryers**

**These warnings are provided in the interest of safety. You must read them carefully before installing or using the appliance.**

- This appliance is designed to be operated by adults. Children should not be allowed to tamper with the controls or play with the product.
- It is dangerous to alter the specifications or attempt to modify this product in any way.
- Any electrical work required to install this appliance should be carried out by a qualified electrician or competent person.
- Any plumbing work required to install this appliance should be carried out by a qualified plumber or competent person.
- This product should be serviced by an authorised Zanussi Network Service Centre. Only genuine Zanussi spare parts should be used.
- Care must be taken to ensure that the appliance does not stand on the electrical supply cable.
- Only tumble dry fabrics which are designed to be tumble dried. If in doubt, consult the manufacturer of that item.
- Always look through the glass door to check if water has drained before opening the door. If water is present, do not open the door before draining the water. If in doubt, refer to your instruction book.
- All packaging and transit bolts must be removed before use. Serious damage can occur to the product and to property if this is not adhered to. See relevant instructions.
- Do not overload the appliance. See relevant section in instruction book.
- This appliance is heavy. Care must be taken when moving it.
- Leave the porthole door slightly ajar between washes to preserve the door seal.
- The glass door becomes very hot during the washing and drying cycle. Keep children away from the vicinity of the appliance.
- Only wash fabrics which are designed to be machine washed. If in doubt, consult the manufacturer of that item.
- Always unplug the appliance and turn off the water after use.
- Before washing, ensure that all pockets are empty and buttons and zips are fastened. Avoid washing frayed or torn articles and treat stains such as paint, ink, rust, and grass before washing. Underwired bras must not be machine washed or tumble dried.
- Any objects such as coins, safety pins, nails, screws, stones or any other hard, sharp material can cause extensive damage and must not be placed into the appliance.
- Garments which are saturated with petroleum products should not be machine washed. If volatile cleaning fluids are used, care should be taken to ensure that the fluid is removed from the garment before placing in the machine.

- 
- Never tumble dry items that have had contact with chemicals such as dry cleaning fluid. These are of a volatile nature and could cause an explosion. Only tumble dry items which have been washed in water or require airing.
  - Wash small items such as socks, laces, washable belts, etc., in a washing bag or pillow case as it is possible for such items to slip down between the tub and the inner drum.
  - Only use the advised quantities of fabric softener. Damage to the fabric can ensue if you over-fill. Refer to the manufacturer's recommendations of quantities.
  - Pets have been known to climb into washing machines. Please check your drum before use.
  - Before the drying cycle, always remove reusable plastic detergent dispensers designed to be placed inside the drum with the clothes, as the plastic is not designed to withstand the heat of the drying cycle.
  - Under no circumstances should you attempt to repair the machine yourself. Repairs carried out by inexperienced persons may cause injury or more serious malfunctioning. Contact your local Zanussi Network Service Centre if a fault occurs. Always insist on genuine Zanussi spare parts.

---

# Contents

Installation	Page 7
Getting to know your machine	Page 12
Energetic wash & dry programmes	Page 16
Gentle wash & dry programmes	Page 18
Using your machine	Page 20
Additional programmes	Page 23
Looking after your machine	Page 25
Helpful washing hints	Page 27
How to wash ...	Page 28
Servicing	Page 30
Building-in instructions	Page 31
Zanussi guarantee conditions	Page 34

Please note that the specifications of your appliance may differ slightly from those shown in this leaflet.

This appliance is easy to use.

To get the best out of it, you should read this booklet and carefully follow all instructions before using the appliance for the first time. The booklet provides not only instructions on installation, use and maintenance, but also gives some very useful hints.

# Specifications

**WDJ1051**

---

## Dimensions

Height	850 mm	33.5"
Width	600 mm	23.6"
Depth	600 mm	23.6"
Weight	82 kg	180 lb
Capacity for wash	4.5 kg	10 lb
Capacity for drying	2.25 kg	5 lb
Revolutions per minute	450 / 1000 Variable	

---

Total power absorbed	20090 W
Heater rating (washing)	1800 W
Heater rating (drying)	1750 W

## Motor rating

Washing	200 W
Spinning	350 W
Voltage	220 / 240 V
Frequency	50 Hz

---

## Pressure psi

Maximum	110
Minimum	7

---

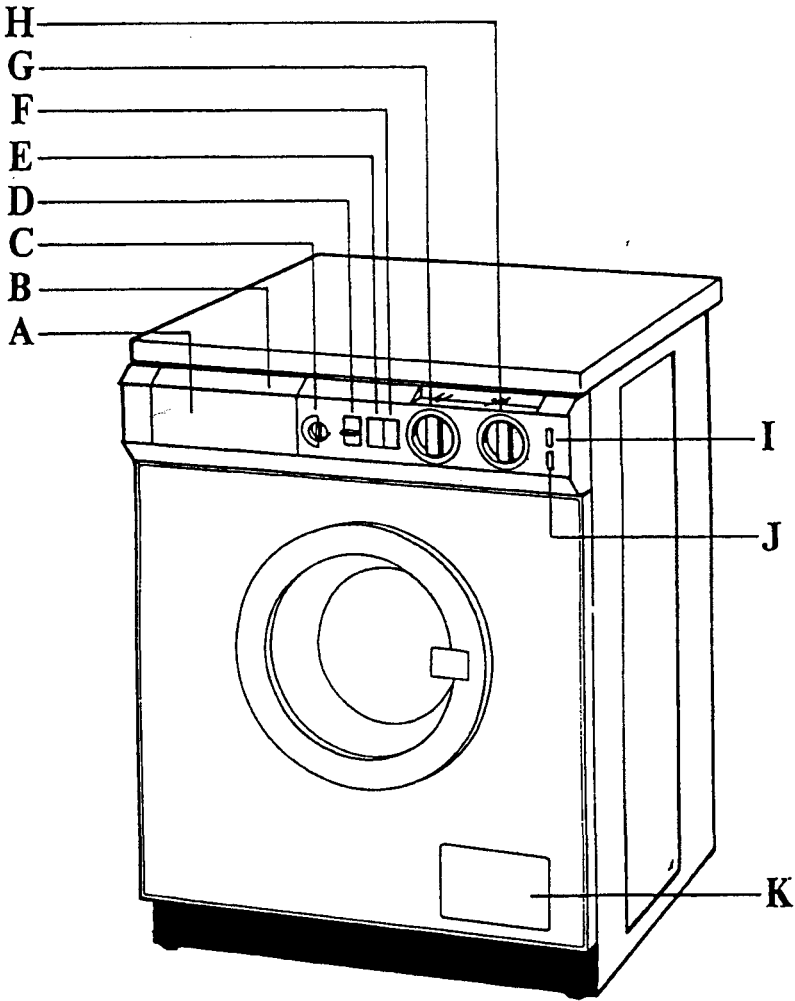

Please note that the external appearance of your appliance may differ slightly from that shown in this instruction book.

- A Programme chart
- B Detergent dispenser
- C Drying time control
- D Spin speed selector
- E Auto-drying pushbutton
- F Quickwash button
- G Temperature and ON/OFF control
- H Programme selector dial
- I Pilot light "Operation"
- J Pilot light "Drying"
- K Drain filter

# Installation

## Unpacking

Having removed the outer carton, reinforcing angles, and polythene wrapping, you must take out the internal packing which protected the appliance's "works" during transit.

1. Using the plastic spanner provided, remove the three large bolts from the back of the machine to free the washing drum (figure 1).
2. Each bolt leaves behind a plastic spacer inside the machine, these should be worked loose by inserting a screwdriver into the bolt hole, and allowing the spacers to drop to the bottom of the machine. Then, close the three open holes by means of the three plastic caps provided with the machine.

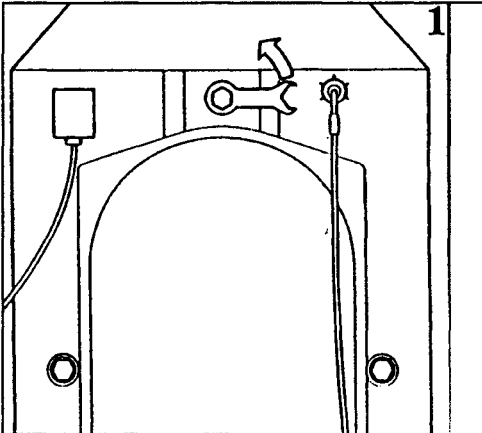

3. Lay the machine carefully on its back to reveal two pieces of polythene band in the base (figure 2). First pull band A then band B to withdraw the remaining internal packing, taking care not to catch and damage any of the appliance's internal components in the process.
4. Finally, lift the appliance off the polystyrene base packing and remove the plastic spacers you worked loose earlier.

These spacers, together with the three large bolts and other packaging should be kept in a safe place so they can be used if the machine has to be transported again.

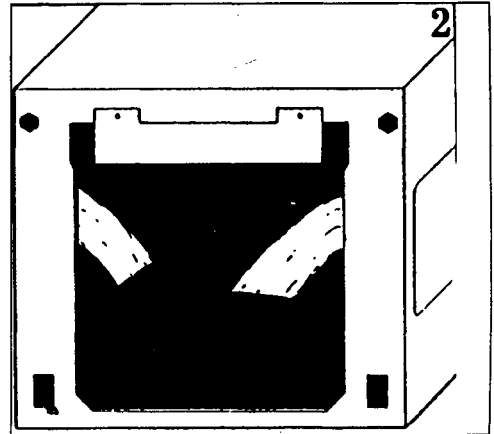

### Positioning and levelling

To keep vibration, noise and movement to a minimum, it is essential that the machine is absolutely level. Check this with a spirit level when the machine is in its permanent operating position. Any adjustments needed can be made by using the open end of the spanner supplied to raise or lower the two adjustable feet at the front of the machine - you merely screw them up or down (figure 3).

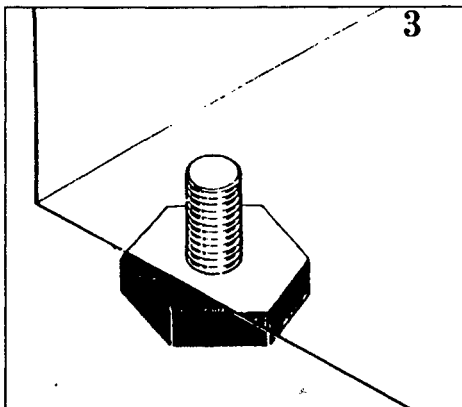

Some vibration is inevitable, especially if mounted on a wooden floor, so make sure there is a gap of at least 12mm (1/2") between the machine and any walls, furniture and so on.

Please ensure that when the appliance is installed, it is easily accessible for the engineer in the event of a breakdown.

### Plumbing - cold water fill only

Your new Zanussi appliance has been designed to be permanently plumbed in to your home's water supply and drainage system. However, if this is not possible, it may be connected to suitable existing taps, with the drain hose discharging into a sink.

The appliance has a cold water inlet valve, with a female 3/4" BSP thread connector. If this connection size is not compatible with your existing plumbing, a variety of connectors are available from good hardware stores and plumbers' merchants to suit most domestic plumbing. Any alterations to your existing plumbing must be carried out by a competent person or qualified plumber. Before connecting the hoses, be sure to fit the mesh filters supplied as per figure 4.

Before connecting the hose, be sure to fit the mesh filter supplied as per diagram.

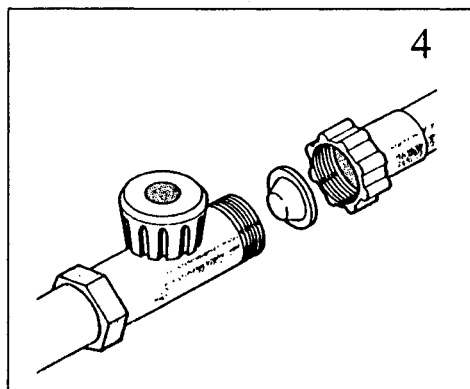



The other end of the hose which is connected to the appliance can be turned in any direction by first loosening the ring nut.

Once the hose has been re-positioned, this must be re-tightened to prevent leakages.

Installation should comply with local water authority and building regulations' requirements.

The appliance must be given a separate cold water supply and not be connected to mixer taps, a single outlet water heater or a booster pump.

A minimum water pressure of 7 psi is required for the safe operation of the appliance. If you cannot make the connection direct from the rising mains, you may be able to operate the appliance from your cold water storage system. There should be a minimum of 5.02 m (16.5 ft) between the appliance's inlet and the bottom of the tank.

If you are operating the appliance on the minimum pressure of 7 psi, it may fill slowly. This flow can be increased by removing the small restrictor contained within the inlet valve. To remove the restrictor, first turn the water off and unplug the appliance. Disconnect the water supply hose from the inlet valve, and pull out the mesh filter inside the valve. Remove the restrictor (a small round washer) with the aid of thin-nosed pliers.

Replace the mesh filter and re-fit the hose.

If the water supply in your area is hard, it is possible that the filters situated in the fill

valves can become blocked with sand or limestone deposits and in extreme cases this can cause a breakdown of the fill valves: i.e. no water fill or continuous filling.

We would suggest that you install supplementary strainers which should be fitted on the fill hoses of your machine. For information about the availability of these supplementary strainers, you should contact your local plumber.

If you intend the drain hose from the machine to empty into a sink, make sure the sink is empty and that the plug hole is not blocked.

Where the machine is permanently plumbed in, hook the end of the hose into a standpipe installed for the purpose.

It should have an internal diameter of at least 38mm (1 1/2"), leaving an air gap between hose and pipe, and should be designed in such a way that the water level in it never covers the end of the hose.

### **Important**

**Before connecting up the machine to new pipework or pipework that has not been used for some time, run off a reasonable amount of water to flush out any debris that may have collected in the pipes.**

Whether discharging into a sink or a standpipe, check that the end of the drain hose is neither too high nor too low. The top of the curve in the hose's end should be no more than 85 cm (34") and no less than 50cm (20") above floor level (figure 5).

**Finally, make sure that with the machine in position, the drain hose is not obstructed, blocked or bent so sharply that water cannot flow freely.**

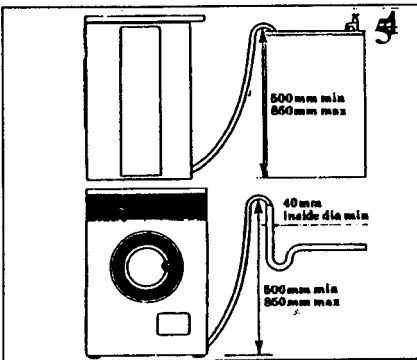

### **WARNING: THIS APPLIANCE MUST BE EARTHED**

The manufacturer declines any liability should this safety measure not be observed.

Before switching on, make sure that the voltage of your electricity supply is the same as that indicated on the rating plate, located inside the cabinet.

This appliance comes complete with either a moulded-on or re-wireable 13 amp (BS1363) plug, protected by a 13 amp ASTA approved (BS1362) fuse.

If you have to change the fuse in the plug supplied, a replacement 13 amp ASTA approved (BS1362) fuse must be used.

For a moulded-on plug, the fuse cover **MUST** be refitted after changing the fuse. If the fuse cover is lost or damaged, the plug **MUST NOT** be used until a replacement is obtained.

Replacement covers are available from your local electricity shop or nearest Customer Service Centre. The colour of the replacement fuse cover must match the coloured insert or emboss on the base of the plug.

For a re-wireable plug, care must be taken to ensure that the top cover is refitted without causing damage to either the top cover or base. If the plug becomes damaged or cracked, it must be replaced with an equivalent 13 amp BS1363 plug (Fig. 1) and re-wired using the following procedure:-

## IMPORTANT

The wires in the mains lead are coloured in accordance with the following code:

<b>Green and Yellow</b>	-	<b>Earth</b>
<b>Blue</b>	-	<b>Neutral</b>
<b>Brown</b>	-	<b>Live</b>

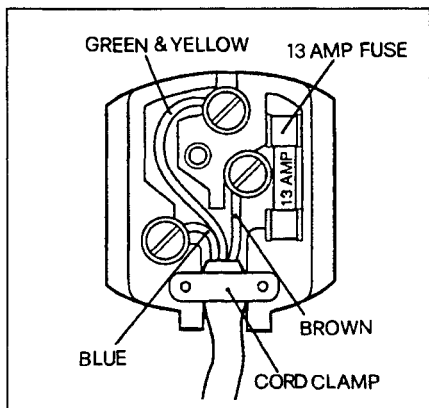

The wire coloured green and yellow (earth) must be connected to the terminal in the plug which is marked with the letter 'E' or the earth symbol  $\oplus$  or coloured green and yellow.

The wire coloured blue (neutral) must be connected to the terminal in the plug which is marked with the letter 'N' or coloured black.

The wire coloured brown (live) must be connected to the terminal in the plug which is marked with the letter 'L' or coloured red.

Upon completion, there must be no cut, loose or stray stands of wire present and the cord clamp must be secure over the outer sheath.

If a 13 amp (BS1363) plug is unsuitable for your socket outlet, the plug should be removed, (cut off in the case of a moulded-on plug) and an appropriate plug fitted.

**NOTE:** Moulded plugs cannot be re-used and should be discarded if cut from a mains lead, as insertion into a 13A socket could prove fatal.

If a non-fused plug is fitted (Fig. 2), the wiring must follow the above procedure and the appliance must be protected by the use of a 15 amp fuse either in the adapter or at the distribution board.

If at any time a replacement supply cord is required, the cross sectional area of its conductors must not be less than 0.75mm<sup>2</sup> and the cable clamp must be tightened so as to fully retain the new cord.







We recommend that this type of installation be checked by a fully qualified electrician.

Please ensure that when the appliance is installed it is easily accessible for the engineer in the event of a breakdown.

**This appliance complies with E.E.C. directive No. 87/308 of 2.6.87 relative to radio interference suppression.**

## Getting to know your machine

### The controls and how to use them

- A Programme chart
- B Detergent dispenser
- C Drying time control 
- D Spin speed selector 
- E Auto-dry button 
- F Quickwash button 
- G Temperature control and ON/OFF control 
- H Programme selector dial
- I Pilot light "Operation" 
- J Pilot light "Drying" 
- K Drain filter (behind the small cover)

#### A Programme chart

This chart will help you to select the correct wash programme. The letter and wash programme numbers correspond to those used in the detailed charts from page 16-19.

#### B Detergent dispenser

The dispenser has three compartments - two for detergent (a and b) and one for fabric conditioner (c) (figure 6 page 21).

The fabric conditioner compartment is fitted with a removable filter. To open the dispenser, gently pull the handle which is at the lower half.

#### C Drying Time Control Knob

This selector allows you to choose the desired drying time according to the type and quantity of the load to be dried. It can also be adjusted whilst the machine is in operation to either increase or reduce the drying time. The control incorporates two drying cycles, one of up to 120 minutes at a high heat for natural fabrics and one of up to

80 minutes at a low heat for synthetic fabrics.

**Never attempt to turn the selector in an anticlockwise direction.**

#### D Spin speed selector

Enables you to select the spin speed you require according to the type of laundry you are washing.

On energetic cycles, the spin speeds vary from 500 - 1000 rpm.

On delicate programmes, to protect the fabrics from damage caused by over-spinning, the speeds vary from 450-850 rpm.

A high spin speed is particularly recommended for laundry to be dried in a tumble dryer, after the wash programme is complete. The lower spin speeds are recommended for delicate laundry, made from natural or synthetic fabric.

#### E Auto-dry button

By depressing this pushbutton when washing only half a load or less, it is possible to programme the machine to run automatically from the wash programme to the drying programme without pausing.

To do this, first select the required wash programme. Depress the Auto-dry button and then select the required drying time. Finally, select the temperature suitable for the wash. After completing the washing cycle, the machine will automatically begin the drying cycle.

The button is operating on cotton and

## **F Quickwash pushbutton**

Press this button when using programme **B** for cotton or **L** for synthetics to reduce the wash times. Ideal for washing lightly soiled items quickly.

## **G Temperature and ON/OFF control**

In addition to starting and stopping this machine, this control is used to select the wash temperature according to the programme which has been selected. The programme charts show the most appropriate temperature for each type of wash.

In the "O" position the machine is off;  
In the "I" position the machine is on.

Adjustable temperatures also makes it possible for both cotton and synthetic washes to be washed at lower temperatures than suggested, or to be washed in cold water. For the latter, the thermostat control should be set at "I".

Remember to press the dial in before turning it, and to switch the machine off, turn the dial in an anticlockwise direction.

## **H Programme selector dial**

The selector dial is marked with letters corresponding to those on the programme chart. To set the machine to the correct programme (see charts from page 16-19), push the dial in and turn it clockwise until the letter you want coincides exactly with the pointer at the top of the dial.

**Never attempt to turn the control dial in an anticlockwise direction.**

## **I Pilot light "operation"**

The pilot light comes on when the machine is set to start.

## **K Drain filter**

This is situated behind the small flap cover at the base of the cabinet. It must be cleaned from time to time (see page 26).

## **J Pilot light "drying"**

The pilot light comes on when the machine is performing a drying programme.

## **The wash programmes**

The Energetic wash cycles (**A** and **B**) for robust fabrics are completely automatic, taking the clothes through washing, rinsing, spinning and draining.

The Gentle wash cycles (**H-L**) are for minimum iron, drip dry and delicate fabrics. The machine stops after the last rinse before the water draining and spinning. The clothes are left suspended in water to prevent them becoming creased by remaining in the bottom of the wash tub in a damp state after spinning.

To complete the cycle, turn the Programme Selector Dial to **N** for water draining followed by a short spin or **P** for drain only if you are washing drip dry articles.

when using a Jetsystem programme the water intake for the wash is totally variable. The machine regulates the amount of water it uses according to the wash load. For example the machine will use more water for a full load of absorbent fabric than a small load of absorbent fabric.

---

## Drying

### Drying

The dryer part of this Washer/Dryer is a Turbo Condenser Dryer.

If you wish to machine dry your laundry at the end of a wash cycle, leave the tap open and the drain hose hooked over the sink or the stand pipe. During the drying cycle, the machine uses a small amount of water.

In this appliance, the clothes are dried by means of a continuous flow of hot air produced by a turbine which, as it passes through the drum, gradually carries away the moisture in the freshly-washed load.

This moisture is then condensed within the machine when it comes into contact with the cold water. The condensed water is then drained away, together with the cooling water, through the drain hose. There is therefore no need to provide special ventilation of the room in which the machine is installed.

To carry out a drying cycle:

1. Remove all spun laundry from the machine.
2. Sort the laundry to be dried from the load.
3. **Important:** Load only up to a maximum of 2.25 kg (5lb) of spun laundry into the drum. Place it in loosely; the load must be able to move freely inside the drum. When drying synthetic clothes, load only up to a maximum of 1 kg (2.2lb).

4. Close the loading door.
5. Set the drying time control as required, using the 0-80 minute "low" sector when drying synthetic items and the 0-120 minute "high" sector when drying cotton fabrics.
6. Turn the programme control to **F** when drying cotton fabrics, and **Q** when drying synthetic items. **Lastly**, press the On/Off pushbutton. The pilot light will come on and the drying cycle will start.

The drying temperature is constantly controlled by a thermostat in order to avoid and excessive increase in temperature.

The duration of the preset drying time may be shortened or extended during the drying cycle. **This should not be done however within the 20 - 0 minute period** because during this time, both the machine and the laundry must be allowed to cool off.

If for any reason the power fails during the drying cycle, it is advisable to remove the clothes as soon as possible. This is because whilst the drum is standing still, there could be a heat build up which could damage the more delicate fabrics being dried.

If you have to interrupt the drying cycle, switch the Temperature and On/Off control to "0" (off) position. Wait for 1-2 minutes before trying to open the door when the Door Safety Interlock will be released.

### **Note:**

Do not interrupt the drying operation when the programme has started running.

A temporary power failure or lack of water may erase the ongoing drying programme. When this occurs, turn off the machine, set up the programme again, and turn on the machine.

### **Auto Dry**

It is possible to programme the machine to run automatically from the wash programme through to the drying programme without pausing. In this case, the wash load must be reduced to a maximum of 2.25 kg (5lb) for cottons and a maximum of 2.5 kg (2.2 lb) for synthetics. This is possible on all programmes except the Wool, Silk and Delicates programmes.

Leave the tap open and the drain hose hooked over the edge of the sink or in the waste pipe.

Proceed as follows:

1. Load the machine.
2. Select the Wash Programme.
3. Depress the Auto Dry Button.
4. Select the Drying Time required, using the 0-80 minute "low" sector for synthetics and the 0-120 minute "high" sector for cottons.  
After spinning the machine will automatically begin the drying cycle.
5. Select the wash temperature required, and the machine will automatically start.

### **Fabric Drying Times**

The drying times of all fabrics will depend on the extent to which they have been spun as well as the fabric characteristics. The higher the spin speed, the shorter the drying time.

To alleviate creasing, all clothes should be removed from the drum as quickly as possible after completion of a drying cycle.





### **Important**

Only laundry washed in water should be dried in this machine. In particular, the following fabrics should not be loaded into the dryer:

- Clothes which were dry-cleaned or cleaned with chemical solvents;
- Woollens or mixed woollens which will shrink with heat;
- Extremely delicate fabrics such as silk and some synthetic curtains;
- Sponge, rubber and similar items;
- Fibre glass items.
- Fabrics which tend to fray as, for example, carding wool, cotton-wool or excessively frayed carpets.

## Energetic Wash Cycles

For cotton, linen and viscose (rayon) fabrics.  
Recommended washload: 4.5 Kg (10 lb) maximum

Wash Programme	Position of programme selector and thermostat	Dispenser compartment	Wash cycle description
Pre-wash	<b>G</b> 30-40°C	<b>a</b>	Cottons and linens, prewash in water at 30-40°C (normal level) followed by soaking phase - laundry is left soaking in water. To drain the water, turn programme control to <b>N</b> (drain with gentle spin) or <b>P</b> (drain only)
Whites 	<b>A</b> 95°C	<b>b c</b>	White cottons and lines without special finishes. Jetsystem wash at 95°C. 3 cold water rinses, spinning.
Fast coloureds 	<b>A</b> 60°C	<b>b c</b>	Cottons, linens and viscose. Main wash at 60°C. 3 cold water rinses, spinning.
Non-fast coloureds 	<b>B</b> 40°C	<b>b c</b>	Cottons, linens and viscose. Jetsystem wash at 40°C. 3 cold water rinses, spinning.
Quickwash Press button 	<b>D</b> 30-60°	<b>b c</b>	Short Jetsystem wash at 60°C. 4 cold water rinses, spinning.

The automatic drying can be obtained by means of programs A B C D by depressing the button  and setting the drying time.



Wash programme	Position of programme selector and thermostat	Dispenser compartment	Wash cycle description
Special treatments	C	c	3 cold water rinses (high level), with intake of water mixed with liquid additive such as fabric conditioner. Special treatment, spinning.
Spin only	D		Spinning for 6 minutes with simultaneous water draining. This is preceded by slow rotations of the drum and followed by a final "shakedown" of the wash.

### Energetic drying programmes (0-120 "high")





Fabric type/ Spin Speed	Programme	Quantity	Drying time	
			Iron dry (mins)	Cupboard dry (mins)
Cotton and linen  (1000 rpm)	F	2.25 kg (5lb)	60-70	80-90
		2.00 kg (4lb)	55-65	70-80
		1.50 kg (3lb)	40-50	60-70
		1.00 kg (2lb)	30-40	45-55

The drying times indicated in this table are for drying cotton towels. By varying the composition of the load, the drying times indicated will vary.

## Gentle wash cycles

For delicates, synthetics including acrylics, acetates, triacetates, machine washable woollens and wool mixes.

Recommended washload: 1.5-2 Kg (3-4 lb) maximum; wool 1 Kg (2 lb) maximum.

Wash programme	Position of Programme selector and thermostat	Dispenser compartment	Wash cycle description
Whites	K 60°	b c	White nylon & polyester cotton mixes. Main wash at 60°C. 2 cold water rinses.
Minimum iron 	K 50°	b c	Coloured synthetic and mixed fabrics. Main wash at 50°C. 2 cold water rinses.
Quickwash Press button 	L 30-60°	b c	Short main wash at 30-60°C. 2 cold water rinses (high level).
Woollens  	H 40°	b c	Machine washable woollen and wool mixtures with cotton or viscose. Wash in water at 40°C (high level). 3 cold water rinses.
Delicates 	J 40°	b c	Acrylics, acetates, triacetates and wool mixtures. Wash in water at 40°C (high level). 3 cold water rinses (high level).
Silks	J 30°C	b c	Silks and printed acetate fabrics. Wash in water at 30°C (high level). 3 cold water rinses.

The automatic drying can be obtained by means of programs K L M N by depressing  button and setting the drying time.

Wash programme	Position of programme selector and thermostat	Dispenser compartment	Wash cycle description
Rinses - Special	M	c	3 cold water rinses (high level), with intake of water mixed with liquid additive such as fabric conditioner.
Short Spin	N		Water draining followed by a short spin.
Drain only	P		Water draining with a steady drum.

There is no water draining after the last rinse of the gentle cycles. This prevents the clothes from creasing if they are left in the machine at the end of the wash cycle.

The clothes are held suspended in water until you turn the selector dial to N when the water will be drained and the clothes will be given a gentle spin. Or, the selector dial can be turned to P when the water will be drained away without spinning.

### Warning

**Do not open the machine door until one of the draining programmes has been completed. If you do, the water will flood out of the machine.**

### Delicate drying programmes (0-80 minutes "low")

Fabric type/ Spin speed	Programme	Quantity	Drying time	
			Iron dry (mins)	Cupboard dry (mins)
Synthetics short spin at 850 rpm)	Q	1.50 kg (3lb)	--	65-75
		1.00 kg (2lb)	--	45-55
		0.50 Kg (1 lb)	--	35-45

The drying times indicated in this table are an indication of the average drying times. More specific times can soon be worked out from personal experience of the machine.

## Using your machine

### Sorting the wash

Sort the clothes and household linen according to fabric, colour fastness and degree of soiling, following the charts from page 16-19. **Check with the wash care label sewn to the garment or article; this should have a number in a wash tub symbol which corresponds to the wash temperature shown on the charts.** For example, if your sheets have a label with number  in the wash tub, you can choose programme A. If the garment has no label, choose the appropriate programme for the fabric. If you are uncertain what the fabric is, always choose one of the gentle wash cycles such as J or H.

Be cautious with coloured items unless they are labelled colourfast, wash them separately by hand, or use the programme for non-fast coloureds.

With the Jetsystem machine you can divide the wash into the correct care label codes and wash them according to the labels' recommendations, confident that you are not being extravagant and that the optimum results are achieved, since the washing machine uses only the amount of water necessary to wash each load.

Similarly, the system allows you to wash individual items since the machine will use only the amount of water necessary to wash that particular item.

This means that you no longer have to mix wash codes together to ensure that you make the best use of the water being taken into the machine which inevitable results in

some of the wash not being cleaned at the most suitable temperature to ensure the best results.

### Loading the clothes

To open the front door, push it on the right inside.

Open the drum loading door by pulling the catch to the left and then forward (figure 6). Place the sorted articles into the drum one by one, shaking them out first. Alternate larger and small items.

**Never hang any laundry on the door!**

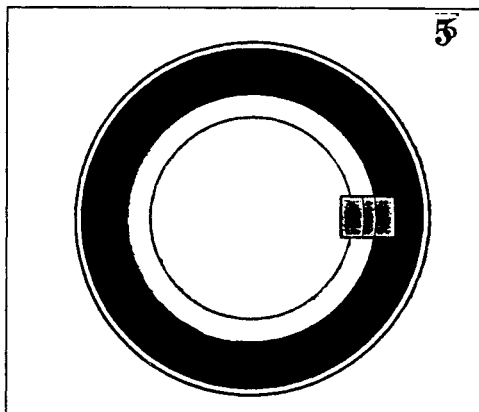

Once the machine is loaded, close the door firmly. Then put the washing powder and conditioner (if required) into the dispenser.

### Warning:

**The glass porthole door can reach high temperatures during washing or drying phases. Please ensure that young children do not touch this area of the appliance.**

**Be sure all pockets are empty, buttons and zips fastened. Avoid washing frayed or torn articles, and treat stains such as pain, ink, rust and grass before washing (see page 29).**

Once the machine is loaded, close the door firmly. Then put the washing powder and conditioner (if required) into the dispenser.

### **Choosing the right washing powder**

Always use a low lather powder. This is important as too much lather prevents the articles from being properly cleansed and tumbling freely.

**Ariel Automatic** is specially designed to complement the cleaning action of the machine.

### **Filling with washing powder**

The washing powder dispenser has three compartments (figure 6). Compartment "a" is for the prewash powder, "b" for the main wash powder, and "c" for fabric conditioner. The same wash powder can be used for the pre and main wash cycles. Pull out the dispenser and add the measured amount of powder, following the directions on the wash powder packet (see also Table on page 22). Be sure to use enough powder. This is essential to get the clothes really clean. Once the dispenser is filled, close it by pushing in gently. This is particularly important if you are using a fabric conditioner because if the drawer is slammed, it will cause the conditioner to enter the machine prematurely.

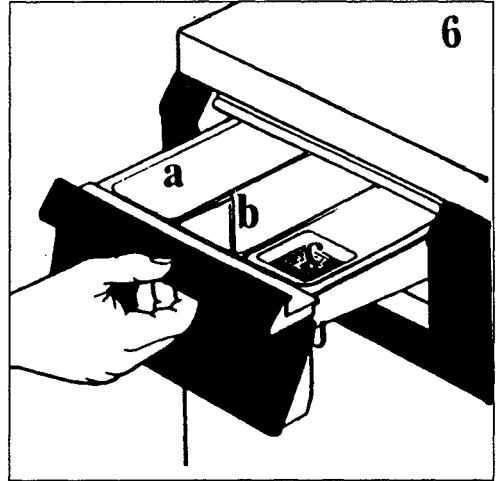

The amount of detergent you should use for your wash depends on a number of factors; how dirty the clothes are, what type of dirt or stains there are to clean, what type of fabric the clothes are made of, and how hard your water is. The following table gives you a guideline of how much detergent to use. We recommend you first try these amounts of detergent, but remember, if the clothes are very dirty or there are stubborn stains, add a bit extra; use less if it is a smaller load; don't be afraid to experiment with different amounts of detergent until you find the best level to give you satisfactory wash results.

## Amount of wash powder in grammes Main Wash

Hardness of water	Load - Dry fabric			
	4.5 Kg	3.5 Kg	2.25 Kg	1 Kg
Soft 0-7 degrees Clark	85 g	75 g	55 g	40 g
Medium 8-14 degrees Clark	120 g	110 g	80 g	60 g
Hard 15-21 degrees Clark	165 g	145 g	110 g	75 g
Very hard 21+ degrees Clark	180 g	160 g	120 g	80 g

**For information regarding the degrees of hardness of water in your area, ask the local Water Authority.**

If you use a pre-wash or soak programme, a half measure of washing powder should be placed in compartment "a".

For only lightly soiled loads, the amount of washing powder or detergent should be reduced accordingly.

## Liquid detergents

Liquid detergents may be very useful above all for the low and medium temperature washing of delicate items or those which are not very dirty.

The dispenser drawer also allows the use of liquid detergents. **In this case you must select programmes without prewash.**

The liquid detergent should be poured into the compartment "b" immediately before starting the programme.

To allow use of liquid detergents, instead of powder, special dispensers are available. Check the instructions given with the liquid detergent, as some brands do not require a dispenser.

These accessories are obtainable as an optional extra from authorized Zanussi Service Centres at a reasonable cost.

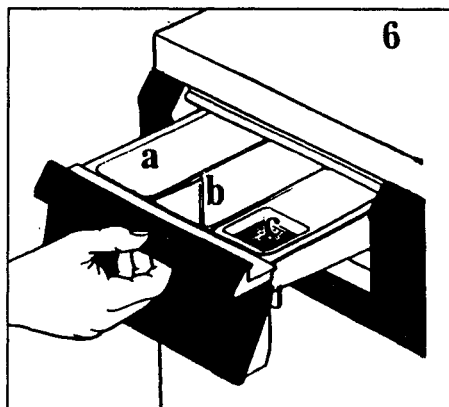

## Using fabric conditioners

When you want to use a conditioner, put the measured amount (follow the manufacturer's instructions) into the compartment "c" in the washing powder dispenser at the same time as you put in the washing powder. **Be careful not to fill the compartment above the level of the filter.**

The conditioner will be automatically used by the machine at the appropriate time. Remember to close the drawer gently.

## To start the machine

Check that:

- the appliance is plugged into the wall socket and the mains is switched on
- the door is properly closed
- the water tap is turned on

Select the programme required by pushing in the central grip and turning the Programme selector dial clockwise so that the required letter is lined up with the red pointer. Select any options such as Quickwash if appropriate, and the required spin speed. Set the drying times if you are using the autodry programme. Next set the temperature control to the required temperature, and the machine will automatically start. When the programme has finished, a white bar will be lined up with the red pointer.

The Operation indicator light will go light up, and after that the machine will automatically perform all of the selected operations.

If necessary, you can stop the machine at any point during the programme by simply pressing and turning the temperature control dial to the OFF position; in this case, wait 1-2 minutes before opening the door to allow time for automatic disconnection of the electrical door lock.

## Unloading the clothes

At the end of the programme, press and turning the temperature control dial to the OFF position.

**If you have been using a gentle wash cycle, do not forget to set the machine to drain the water (programme N or P) before opening the door.**

You can then open the door and unload the machine.

## Additional programmes

### Spin only

This programme can be used to remove water from hand washed articles or any laundry which may have got wet but does not need washing. For example, washing left on the line during a rainstorm. See pages 17 and 19.

















### Special treatments

If you want to treat an article with fabric conditioner without washing it first, you can do this on either programme C or M, according to the fabric.

## The wash symbols

The familiar wash code symbols which are found on the care labels in most clothes will gradually disappear and a new set of codes will be introduced. This change is due to changes in fabrics and detergents

and because people are tending to use fewer wash programmes and mix fabrics in one load. The change will bring the codes into line with the labelling used in the rest of Europe.

Old Symbol	New Symbol	Wash Action	Fabric
		Normal (Maximum)	White Cotton or Linen without Special Finishes.
		Normal (Maximum)	Cotton, Linen or Viscose without Special Finishes colourfast at 60°C
	No longer used. White Nylon, Polyester/Cotton mixtures. Now included in		
		Reduced (Medium)	Nylon, Polyester / Cotton, Viscose with Special Finishes: Cotton / Acrylic mix.
		Normal (Maximum)	Cotton, Linen or Viscose Colourfast at 40°C but not at 60°C.
		Reduced (Medium)	Acrylics, Acetate, Triacetate, Wool mixes, Polyester / wool blends.
		Much reduced (Minimum)	Wool, Wool mixes, Silks.
	No longer used. Silk now included in		 ; printed acetate now included in 
	No longer used.		

The new wash symbols have been used on the Programme Guide of this machine, and are listed, with reference to the old symbols, in the Programme Charts on pages 14 and 17. The new wash symbols will also appear on the side of Washing Powder packets.



---

## Looking after your machine

### **Important**

**Make sure that the machine is unplugged and that the water taps are turned off before undertaking any kind of maintenance.**

### **General care and cleaning**

Wipe around the rubber door seal to remove the water which collects in it.

From time to time, clean polished, plated and plastic parts and the glass porthole door with a soft damp cloth. **Never use abrasive powders.**

Wipe over the exterior cabinet with a lukewarm solution of mild liquid cleaner, rinse and dry thoroughly. From time to time, apply a little wax furniture cream with a soft cloth.

## Cleaning the drain filter

The drain filter should be inspected after each wash.

Open the small flap door (figure 7). Unscrew and pull out the filter (figure 7-8). Underneath the filter there is a small extractable gutter which makes it easier to collect any residual water that might flow out when the filter is removed. Remove any object or fluff and replace the filter. Make sure that all holes in the filter are clear. Special care should be taken with the fine ones at the base of the filter.

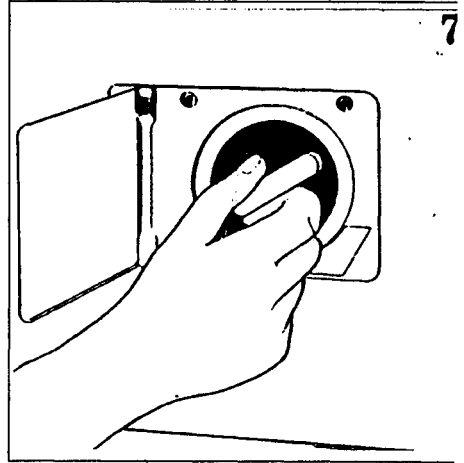

## Cleaning the inlet filter

This is situated at the back of the machine and should be inspected from time to time. Turn off the water tap. Unscrew the hose and remove the mesh filter lodged just inside the hose. Run it under a fast running tap to remove any sediment. Replace the mesh filter and the hose firmly.

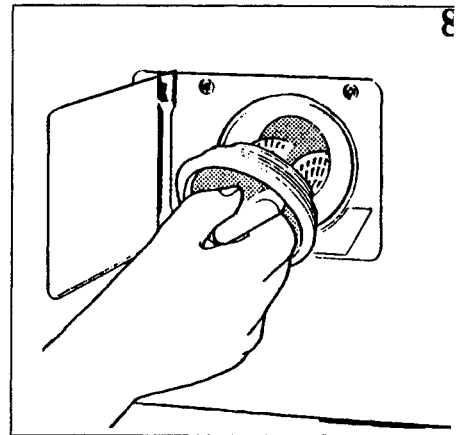

## Cleaning the washing powder dispenser

Wipe it out after every wash.

From time to time it will need more thorough cleaning to clear out all the deposit. Remove the drawer completely with a sharp pull outwards using both hands to pull the drawer out evenly. When you replace it, if you find that it doesn't slide right in again, give it a sharp tap with the palm of your hand.

---

## Helpful tips for successful washing

### **Here are some practical hints to help you get the best washing results.**

Don't overload the machine. The clothes will not move around freely and the washing powder may not dissolve properly.

Always use a low lather washing powder specially made for front loading machines. Excessive foaming gives an unsatisfactory wash and may even harm the machine. The quantity of washing powder required depends on the amount of laundry and how soiled it is.

It may therefore be necessary to vary the quantities suggested on page 23. You will be able to tell if you need to do this when you are used to the machine.

Don't put washing powder into the dispenser until just before starting the programme. If the powder is left for any length of time in the dispenser it may form lumps which are difficult to dissolve.

For best results, do not wash more than 1Kg (2 lb) of woollen articles at any time.

Wash only woollen articles marked "machine washable".

For best results, do not wash more than 1.5Kg (3-5 lb) of synthetic fabrics in one load. Synthetic fabrics need plenty of room to move around or they tend to crease.

Clothes should be sorted according to the fabric, colour fastness and degree of soiling (see page 22).

Mend open seams and tears before washing.

Close zips, empty pockets and secure buttons. Collect laces, washable belts, socks, etc., and put them in a bag for washing.

**(This is important as should a coin become lodged between the tub and drum it can cause extensive damage).**

Remove spots of rust, paint, ink and grass stains before washing (see instructions page 30).

Don't wash light coloured fabrics with dark ones. One may leave specks of fluff on the other.

Don't risk washing coloured articles unless you are sure they are colourfast. It's worth hand washing the article to find out.

If you live in a hard water area, you can add water softening powder to the washing machine in compartment "b". For the quantity of water softener to use, see packet directions.

### Nappies

Leave the soiled nappies soaking in a solution of proprietary nappy cleaner. When there are sufficient for a wash, drain off the water (this is advisable as some nappy cleansers have an adverse effect on the rubber door seal), then transfer the nappies to the washing machine. Set the selector dial to programme **D** (fast spin) to remove excess solution. Then wash the nappies on programme **A** (whites). Dry and air them thoroughly.

### Blankets

Only wash blankets which are labelled as suitable for machine washing. Use wash programme **H** (woollens) followed by programme **N** (drain and spin) which will remove the excess water and leave the blanket ready to tumble dry or hang out on a line.

### Curtains

Check that the fabric is washable. Remove all the curtain hooks and if the heading is drawn up by means of a curtain tape, release the strings to allow the fabric to spread flat. Weigh the curtains and decide if you can wash them in one or more loads. Select the correct programme for the fabric. If the curtains have not been washed for some time, they may be dusty, in which case it is a good idea to rinse them on programme **C** or **M**. After draining, start the suitable wash programme.

### Dyeing

You can dye fabrics successfully in the machine but it is essential to buy a good proprietary dye and to read the manufacturer's instructions carefully. The dye instructions will guide you on this point. Then wash the article to make sure it is thoroughly clean, using a suitable programme according to the fabric. Then follow the instructions for machine dyeing. Immediately after you have removed the dyed material from the machine, set it to a 40° programme to clean all traces of dye from the machine.

It is not absolutely necessary to add washing powder to the dispenser for this, however, you can add it if you prefer.

---

## Stain removal

Some stains will not be removed in the wash. It is wise to treat them before laundering.

The following are simple but effective treatments to use on any washable fabric. Treat the stain as soon as possible and launder soon afterwards to remove any residual stain.

### **Ballpoint and felt-tip ink:**

Dab with methylated spirit on cotton, wool (not on acetate or triacetate fabric). (Test an inconspicuous corner of the fabric first).

### **Fountain pen ink:**

Sponge with cold water to flush out as much ink as possible, or hold the fabric under running cold water. Launder and treat any remaining stains with lemon juice.

### **Grass stains:**

Dab with methylated spirit (not on acetate or triacetate fabric). Rinse in clear water.

### **Oil:**

If heavy stains from cycle chain or car oil do not come out in the wash, treat them with a proprietary grease solvent.

### **Paint - Emulsion:**

Sponge immediately with cold water and then launder. If the stain has dried, soften it with methylated spirit or a proprietary paint brush cleaner. (Test an inconspicuous corner of the fabric first).

### **Paint - Gloss:**

Dab with methylated spirit or proprietary brush cleaner (not on acetate or triacetate fabric). (Test an inconspicuous corner of the fabric first).

### **Rust (iron mould):**

Rub with lemon juice and then sprinkle salt over the stain and leave for an hour. If subsequent washing does not remove the stain, use a proprietary rust cleaner following carefully the manufacturer's directions.

## Servicing

If, having followed these instructions carefully, your machine fails to work properly, contact your local Zanussi Service Network, giving the full model number and date of purchase if the appliance is under guarantee.

Details of your local Zanussi Network Service Centre can be found by looking in your local British Telecom phone book under "Z" for Zanussi.

Before you do that, though, it is worth making a few simple checks yourself.

### If the machine won't start...

- Ensure that the thermostat dial is not in the "O" position.
- Make sure that the door of the machine is firmly shut.
- Make sure that the appliance is properly plugged in and that the socket switch (if any), is in the "On" position.
- Check that there is power at the socket by plugging in an appliance you know to be working - a small lamp for example. If this too fails to work, check the main circuit fuses in your home's consumer unit or main fuse box.

### If the machine won't fill...

- Make sure that the supply hose is not kinked.
- Make sure that all water taps are turned on.
- Check that there is sufficient water pressure. A way to check this is to place a two gallon bucket under the water feed pipe to the appliance and turn on the tap. The bucket should fill in about one minute.

### If the machine won't drain or spin...

- Unhook the drain hose from the drain pipe or sink and hold the hose over a bowl on the floor. The water should drain by gravity into the bowl. If the bowl

becomes full, hook the hose back up and empty the bowl. Repeat the procedure until the water has drained from the machine.

- Then check that the drain filter in the machine is not clogged.

### If the machine empties as it fills...

- Make sure that the end of the drain hose is not less than 50cm (20") above floor level.

### If the machine vibrates badly, or is too noisy...

- Check that the machine is absolutely level.
- Check that there is sufficient clearance between the machine and wall, furniture, etc.
- Check that all the internal packing, plastic spacers and transit security bolts have been removed as described at the start of these instructions.

### If the machine does not dry...

Check that

- the drying programme has been correctly selected.
- the cold water tap is open.
- the drainage filter is not clogged.
- the laundry does not exceed the maximum weight (2.25 Kg - 5 lb max for cotton; 1.5Kg - 3 lb max for synthetics).
- the programmed drying time is adequate for the purpose.

### If the door does not open

- Select the draining cycle.

**Failure to observe these checks could result in your being charged for the service call when requested.**

\*Please note that it will be necessary to provide proof of purchase for any in-guarantee service calls.

## Building-in instructions

If desired, this washing machine can be built-in to a run of kitchen units in place of a unit 600mm wide and 600mm deep. This will leave the integral worktop at a height of 850mm which is compatible with most modern units, however, if you prefer, the machine can be inserted beneath an existing worktop.

In this case, there must be at least 820mm between the floor and the underside of the existing worktop and it is necessary to replace the worktop with a protective metal panel, available from your dealer as an optional extra on application.

To change the worktop, proceed as follows;

1. To remove the integral worktop, undo the retaining screws at the rear of the machine, push the worktop back slightly and lift it clear.
2. Remove the two brackets that helped secure the worktop by undoing the screws holding them to the cabinet.
3. Carefully position the protective metal panel on top of the machine, and fix in place by driving home the four screws supplied with the panel.

Having made the necessary electrical and plumbing connections as already described (see page 7-8), you can now simply manoeuvre the machine into position. Take care, though, that in the process, the fill and drain hoses are not kinked in such a way as to obstruct the flow of water, and ensure that you can still easily reach the power socket into which the machine is plugged.

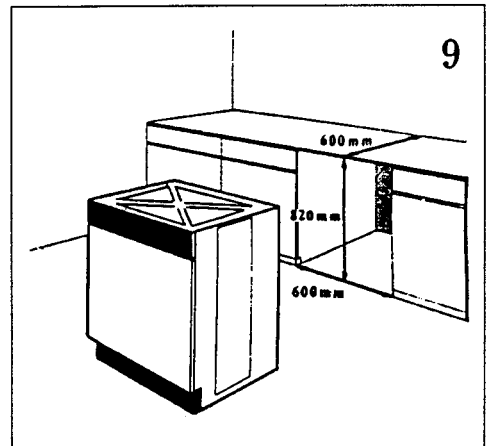

### Instructions for door reversal

The door of this washing machine is suitable for door reversal.

To carry out this operation, proceed as follows:

- a) Bend and disengage the end of the closing catch from the door (1 figure 10), then rotate it 90° to remove it from its seating;
- b) Using a screwdriver, rotate the plastic cap (2 figure 10) 90° and remove it;
- c) Fit the cap (2 figure 11) in the hole left free by the closing catch and rotate it 90° so as to lock it in position;
- d) Fit the closing catch and rotate 90° (1 figure 11) in the hole left free by the cap, making sure that the engaging tooth is facing towards the right side;
- e) Remove the door by unscrewing the two screws fastening the bottom hinge (3 figure 10).

Keep the hinge for possible future use if it is required to return the door to its original opening position.

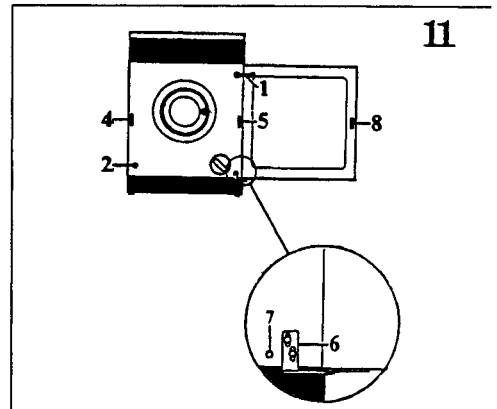
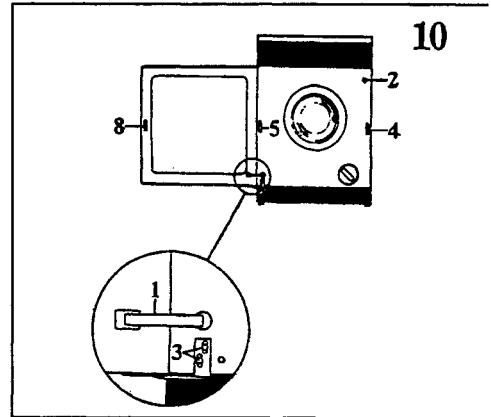



**f)** Remove the stop hook (4 figure 10) after having removed the fixing screws from the cabinet. Take out stud 5 (figure 10) pulling it outwards from the bottom and then rotate it by 90°. Refit the stop hook (4 figure 11) and stud 5 (figure 11) on the opposite side. Displace door closure (8 figure 10) bending the two fastening wings in the direction of the arrows on the closure itself. Turn the closure upside down and push it till fastening of the two wings.

**g)** Fasten the door on the opposite side by means of hinge (6 figure 11) provided as an attachment and using the two previously removed screws. Check that the door is aligned with the cabinet; to make this operation easy, it is advisable to unloose the screw (7 figure 11) provided next to the hinge's fastening holes by two turns, then tighten the screw again.

**h)** Fit into the seating provided on the door, the flexible end of the door closing catch (1 figure 11).

### **Instructions for fitting decor panel on door panel**

The door of this washing machine is provided with frames for fitting a decor panel (kitchen laminates, etc.) to match the washing machine's appearance with that of the kitchen furniture.

The overall dimensions of the decor panel should be as follows:

<b>Width</b>	<b>588 mm</b>
<b>Height</b>	<b>588 mm</b>
<b>Max thickness</b>	<b>4 mm</b>

To fit the decor panel, it is necessary to release the decor frames by removing the fastening screws.

Fit the decor panel and re-assemble all the parts ensuring that the decor panel is secured within the frames.

### ZANUSSI STANDARD GUARANTEE CONDITIONS

This guarantee is in addition to your statutory and other legal rights which will not be excluded or in any way diminished by the return of this guarantee card.

We, ZANUSSI Ltd, undertake that if, within twelve months of the date of the purchase, this ZANUSSI appliance or any part thereof is proved to be defective by reason only of faulty workmanship or materials, we will, at our option, repair or replace the same **FREE OF ANY CHARGE** for labour, materials or carriage, on condition that:

- The appliance has been correctly installed and used only on the electricity supply stated on the rating plate.
- The appliance has been used for normal domestic purposes only, and in accordance with the manufacturer's operating and maintenance instructions.
- The appliance has not been serviced, maintained, repaired, taken apart or tampered with by any person not authorised by us.
- The appliance is still in the possession of the original purchaser.
- All service work under this guarantee must be undertaken by a Zanussi Network Service Centre.
- Any appliance or defective part replaced shall become our property.

### Exclusions

- Damage or calls resulting from transportation, improper use or neglect, the replacement of any light bulbs or removable parts of glass or plastic.
- Costs incurred for calls to put right machines improperly installed or calls to machines outside the UK and the Republic of Ireland.
- Appliances found to be in use within a commercial environment, plus those which are the subject of rental agreements.



# **ZANUSSI**

**The appliance of Science**

ZANUSSI Ltd., Zanussi House, Hambridge Road, Newbury, Berkshire, RG14 5EP

The information in this manual is correct at time of going to press. Zanussi reserve the right to alter specifications without notice.